



**MCP 3000**  
Master Control Panel

## MCP 3000 Master Control Panel

The MCP 3000 Master Control Panel provides generator management and load management (load add/shed) for generator sets equipped with a Decision-Maker® 6000 controller. The MCP 3000 is capable of managing up to eight (8) generator sets on an isolated bus.

## Standard Features

The MCP 3000 provides the following:

- Generator management
- **Load management (load add/shed)**
  - **Seven load add relays**
  - **Seven load shed relays**
- 7.5 inch color touchscreen
- Graphical system overview
- Individual generator set stop/start
- No-load test
- Electrical metering of the generator sets
- Mechanical metering of the generator sets
- Alarm and event logging

## Available Option

- IBC Seismic Certification available

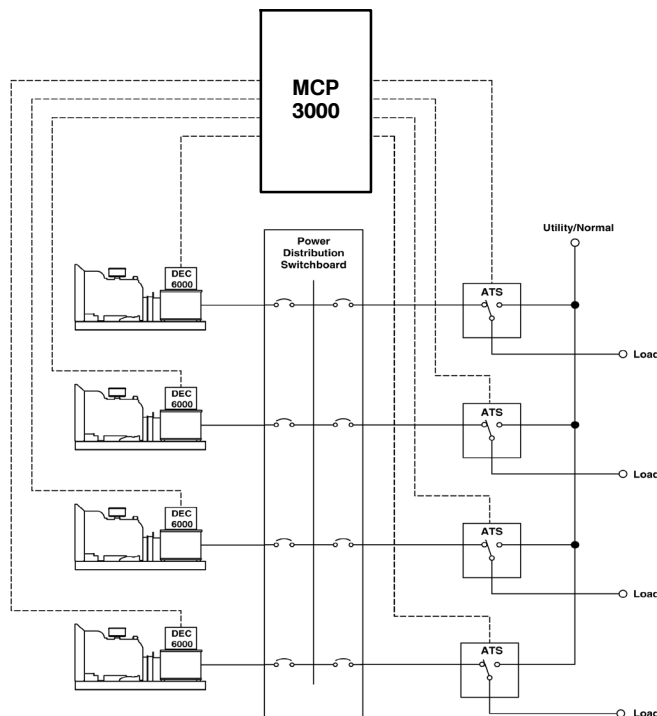

---

# MCP 3000 Functions and Specifications

## Controls

- Generator Set Control
  - Auto
  - Off
  - Run
- Load Management Control (up to 7 loads)
  - Auto
  - Bypass
  - Shed
  - Manual load add
  - Reset
- No-Load Test
  - Start
  - Stop
  - Test duration, minutes

## Adjustable Parameters

- Generator Management
  - Order selection method, runtime or manual
  - Minimum number of generators online
  - Load stable time delay
  - Next start load level and time delay
  - Next stop load level and time delay
  - Overload % and time delay
- Load Management, Load Add
  - Load add time delay
  - Maximum load level to autoloading, %kW
- Load Management, Load Shed
  - Load shed relay priority level
  - Overload setpoint kW
  - Overload shed timer
  - Under frequency load shed setpoint
  - Under frequency load shed timer
  - Under frequency load shed priority level

## Monitoring

- Electrical Metering
  - Power, kW
  - Voltage, VAC (Average, AN, BN, CN, AB, BC, CA)
  - Current, Amps (Average, A, B, C)
  - Frequency, Hz
  - Power factor
  - Loading, %
- Mechanical Metering
  - Oil pressure, PSI
  - Coolant temperature
  - Battery voltage, VDC
  - Engine speed, RPM
  - Engine run time
  - Number of starts
- Alarm and Event Log
  - Alarm list
  - Event list (at least 100 events)
- Generator Management Status
  - System capacity
  - System load
- Load Management Status
  - Load priority settings
  - System load
  - System capacity
  - Load add/shed status

## Specifications

- UL508 listed
- Wall-mounted NEMA 1 enclosure for indoor installation
- 7.5 inch color human-machine interface (HMI) touchscreen
- 24 VDC power required
- Environmental specifications:
  - Operating temperature: 0° to 50°C. (32° to 122°F)
  - Storage temperature: -20° to 60°C (-4° to 140°F)
  - Maximum operating humidity: 93% (non-condensing)
- Dimensions, L x D x H, mm (in.):  
450 x 182 x 791 (17.7 x 7.2 x 31.1)
- Weight: 28 kg (62 lbs.)

# Paralleling System Operation

## System Operation

When the Master Control Panel receives a start signal from one or more automatic transfer switch(es), the lower priority loads are signaled to shed and the generator sets are signaled to start. The first generator set to reach rated frequency and voltage connects to the generator paralleling bus. The remaining generator sets then synchronize to the paralleling bus. As additional generator sets connect to the bus, lower priority loads are signaled to add.

## Graphical System Overview

The main screen graphically depicts system operation including:

- Generator set status
- Generator set metering
- System or generator set alarms

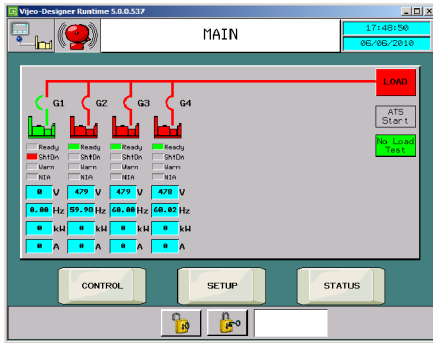

## Load Management

Load management (Load Add/Shed) provides dry contacts to control the loads connected to the generator sets.

Seven (7) load shed relays are provided. The customer assigns a priority level to each load shed relay. The customer also configures the criteria and time delays for load shed (disconnect) and load add (connect) for each priority level.

Load add is based on the number of generator sets on-line and/or kW capacity. The method of load add is user-configurable.

Load shed is based on underfrequency and/or kW overload. Time delays can be set to control the load shed sequence.

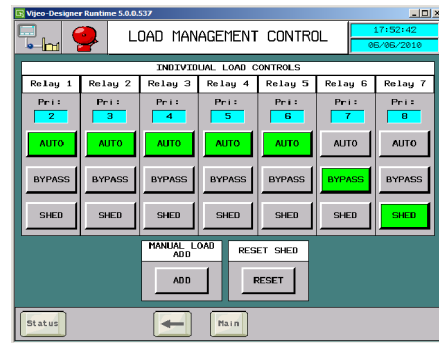

## Individual Generator Set Start/Stop

The individual control screen allows the operator to run each generator set in the system.

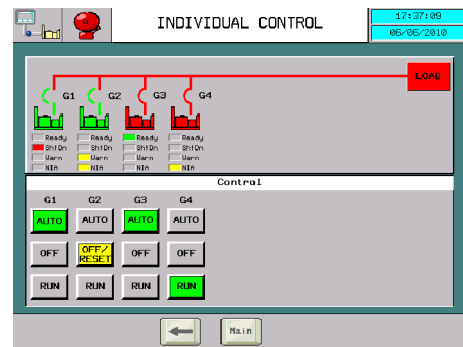

## Generator Management

Generator management optimizes the number of on-line generator sets based on the kW demand of the load. After a user-configured load stable time delay, generator management starts and stops generator sets based on the requirements of the load.

The customer assigns each generator set a priority level. Higher priority units are sequenced on in the order of their priority and taken off in reverse priority. User-defined setpoints determine percent load level and the time delay before each generator set is brought on or taken off line.

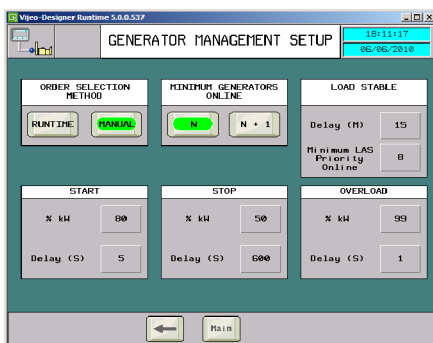

## No Load Test

No load test allows the user to test the system from the touchscreen on the Master Control Panel.

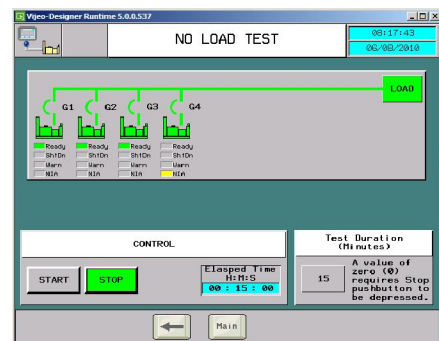

## Electrical Metering

The electrical metering screen allows the user to view electrical system information for each generator set. The multi-gen metering display shows system information for multiple generator sets for easy comparison.

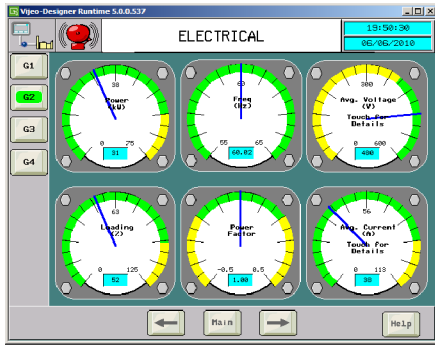

	G1	G2	G3	G4
Volts A_B:	479	479	478	478
Volts B_C:	482	479	478	478
Volts C_A:	478	479	479	479
Amps A:	35	115	106	
Amps B:	38	101	118	
Amps C:	35	112	111	
Freq:	59.94	59.97	60.01	
kW:	38	82	82	
pf:	1.00	0.99	0.99	
Percent Ldg:	58	51	51	

## Mechanical Metering

The mechanical metering screen allows the user to monitor mechanical engine information for each generator set.

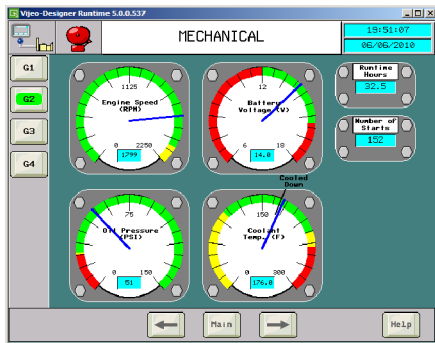

## Alarms

The Alarm screen allows the user to view system alarms, logged events, and alarm status.

Date	Time	Message	St
06/06/2010	19:50:30	Gen 1 - Emergency Stop	ACK'D
06/06/2010	19:51:07	Gen 1 - Low RPM - Not in Manual Prog	ACK'D
06/06/2010	19:51:07	Gen 1 - Shutdown	ACK'D

## History

The history screen allows the user to view past alarms, start and stop history, and all system events.

Date	Time	Message	St
06/06/2010	19:51:07	Gen 1 - Emergency Stop	ACK'D
06/06/2010	19:51:07	Gen 1 - Shutdown	ACK'D
06/06/2010	19:51:07	Gen 1 - Emergency Stop	ACK'D
06/06/2010	19:51:07	Gen 1 - Shutdown	ACK'D
06/06/2010	19:51:07	Gen 1 - Emergency Stop	ACK'D
06/06/2010	19:51:07	Gen 1 - Low RPM - Not in Manual Prog	ACK'D
06/06/2010	19:51:07	Gen 1 - Shutdown	ACK'D

**DISTRIBUTED BY:**

Availability is subject to change without notice. Kohler Co. reserves the right to change the design or specifications without notice and without any obligation or liability whatsoever. Contact your local Kohler® Power Systems distributor for availability.